

LISTA RICAMBI

CODICE: 8.601.0130 REV.: 1 DESCRIZIONE: IDRO EASY 1900 S/ASP. EU -N- LWS (2.5HP) (NORMA)

DATA INIZIO VAL.: 11/18/2009 DATA FINE VAL.: 01/01/3000

CODICE GRUPPO: R50090001 REV.: 2 DESCRIZIONE: BODY PUMP

DATA INIZIO VAL.: 12/02/2008 DATA FINE VAL.: 01/01/3000 N. TAVOLA: E8601A004/01

CODICE:	DESCRIZIONE:	QTA':	POS:	RIF1:	RIF2:
3.650.0001	OIL SEAL 17X30X6 154F-2.5HP (r.13180)	1	01		
6.005.0021	KIT 24 LAVOR	1	02		
4.005.0265	WOBBLE PLATE 9DEG30'SLOPE-TH.P T'03 INT.FL.-MACHINED-	1	03		
4.007.0328	THRUST BEARING 35X55X12 PT'03 REV.03	1	04		
6.005.0225	PISTON KIT	1	05		
3.106.0021	THERMAL VALVE 1/4 NPT WITH CUP	1	07		
5.009.0647	TS VALVE ASSEMBLY	1	08		
6.005.0210	KIT 193 LW VALVE GUIDE RID.+ PO RTAG.PT'03	1	09		
6.005.0184	KIT 170 LW HEAD VALVE KIT	1	10		
6.005.0133	KIT 124 O-RING WATER SEAL PARTNER D.12	1	12		
6.005.0134	KIT 125 O-RING SEAL	1	13		
6.005.0226	KIT 209 O-RING	1	14		
6.005.0079	KIT 79 LW OIL SEALS	1	15		
4.005.0248	HORIZONTAL THERMIC ENGINE FLAN GE 2.5 HP	1	16		
6.605.0093	DIPSTICK SUB ASSY	1	17		
5.007.0223	BODY GUIDE	1	18		
5.008.0182	'03 PARTNER HEAD D.12	1	19		

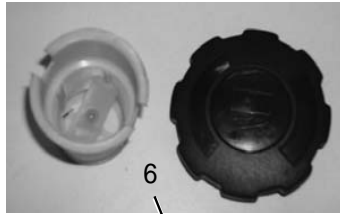

OIL:
SAE 15 W40

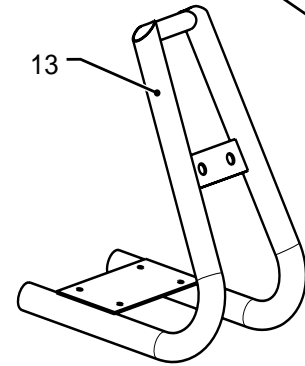
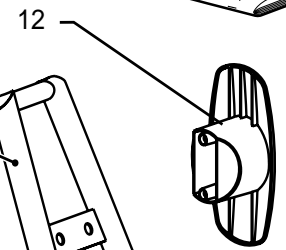
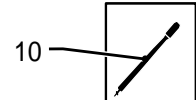
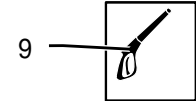
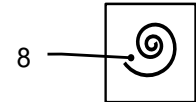
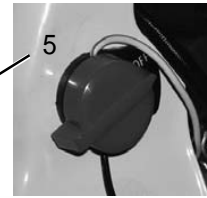
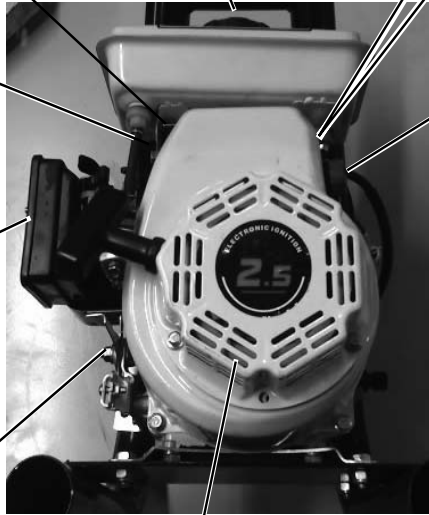

LISTA RICAMBI

CODICE: 8.601.0130 REV.: 1 DESCRIZIONE: IDRO EASY 1900 S/ASP. EU -N- LWS (2.5HP) (NORMA)

DATA INIZIO VAL.: 11/18/2009 DATA FINE VAL.: 01/01/3000

CODICE GRUPPO: R86010130 REV.: 1 DESCRIZIONE: CHASSIS

DATA INIZIO VAL.: 11/18/2009 DATA FINE VAL.: 01/01/3000 N. TAVOLA: E8601C011/01

CODICE:	DESCRIZIONE:	QTA':	POS:	RIF1:	RIF2:
3.650.0019	SPARK PLUG 154F-2.5HP(r.34200)	1	01		
6.605.0095	AIR FILTER KIT	1	02		
3.650.0020	CARBURETOR ASSY 154F-2.5HP (r. 16100)	1	03		
3.650.0024	RECOIL STARTER 154F-2.5HP (r.2 7300)	1	04		
3.650.0015	IGNITION SWITCH 154F-2.5HP 168 F-5.5HP (r.35410)	1	05		
6.605.0094	CAP+GASOIL FILTER KIT	1	06		
3.650.0022	IGNITION COIL 154F-2.5HP (r.34 500)	1	07		
4.018.0051	1/4 HOSE 140 BAR L.5000 1/4F.+D.15	1	08		
6.001.0067	GUN S'01-EU-INTERM.SECURITY PI N YELLOW PANT.108 -C- REV.00	1	09		
6.002.0213C	LANCE	1	10		
7.100.1596	INSTRUCTION MANUAL	1	11		
5.013.0058	COMPLETE FRAME	1	13		
3.600.0029	LIFAN ENGINE 2,5HP X PT'03(HOR IZ.FLANGE)TYPE154 KEY 65mm -B-	1	14		